



Electric Double Layer Capacitor

SM-series

MAY. 2007



www.korchip.com



1. Electric Double Layer Capacitor

1-1 Structure & Material

1-2 Features & Specifications

1-3 Dimensions in mm

1-4 Carrier tape dimension in mm

1-5 Reflow Soldering Condition



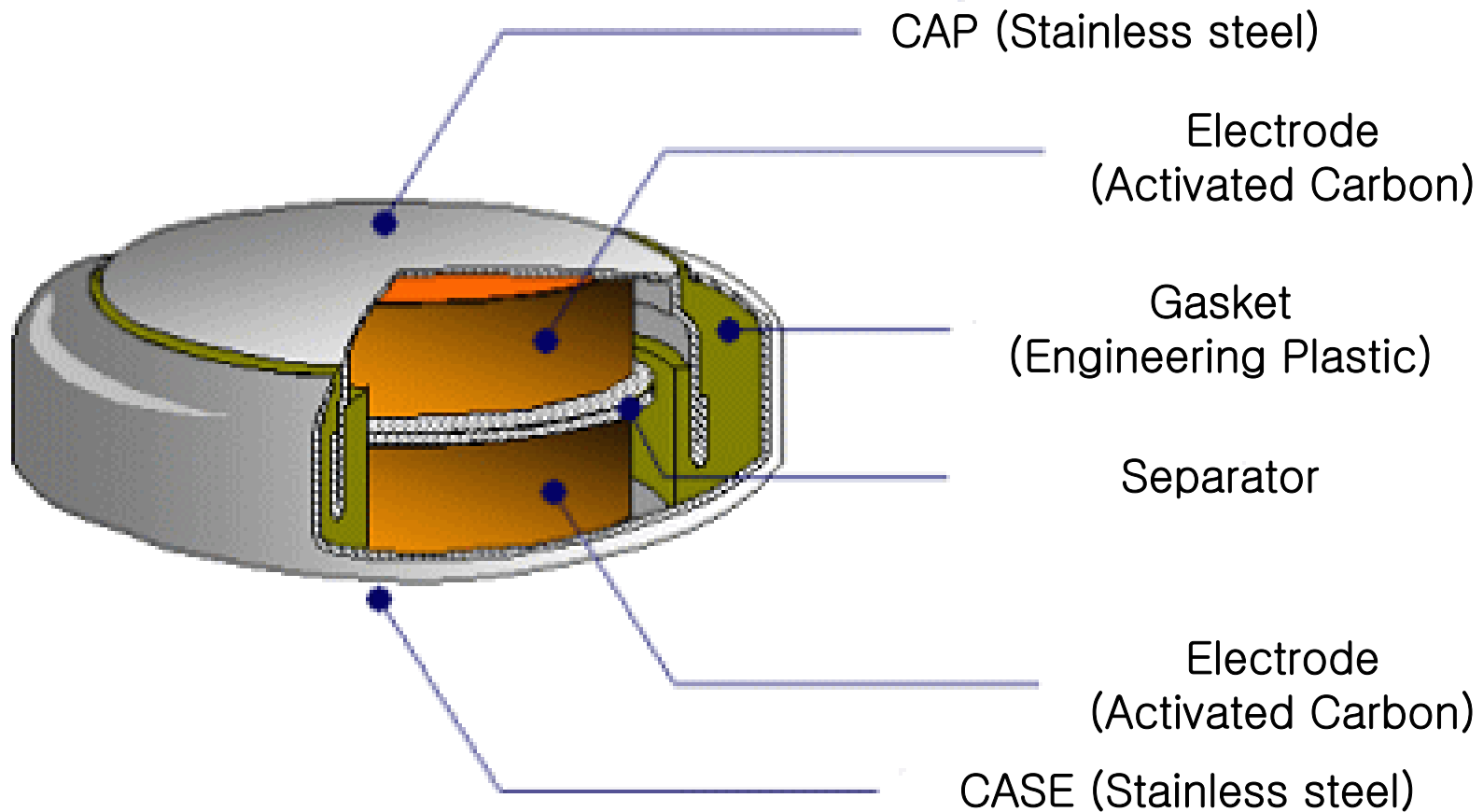

● Features

- Can be used as a rechargeable battery and ideal for backing up purposes
- Eco-friendly
 - : It does not contain toxic materials such as nickel and cadmium
- Reflow soldering available
 - : The best's heat resistance (260°C peak) allows reflow soldering by Pb-free solder
- Long cycle Life
 - : More than 100,000 time Charge-Discharge cycle (3.3V ~ 0V)
- High-rated voltage
 - : Able to be used at wide range voltage from 0V to 3.3V
- Small sized and Large capacity
 - : 0.07F with Ø4.8 x 1.4mm

● Specifications

Part number	Operating Voltage (V)	Capacitance (F)	ESR (Ω , @1kHz)	$\Phi D \times L \times P$ (mm)
SC SM 2R5 104	2.5	0.10	100	Ø4.8×1.4
SC SM 3R3 703	3.3	0.07	100	Ø4.8×1.4

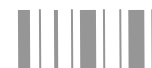

● SM3R3703 H01

Not to scale

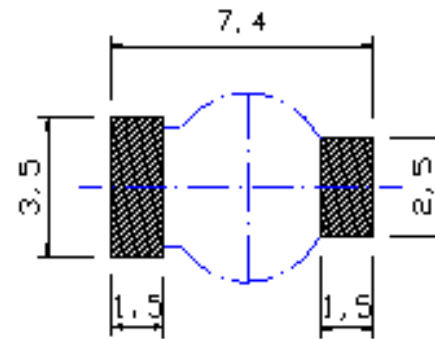
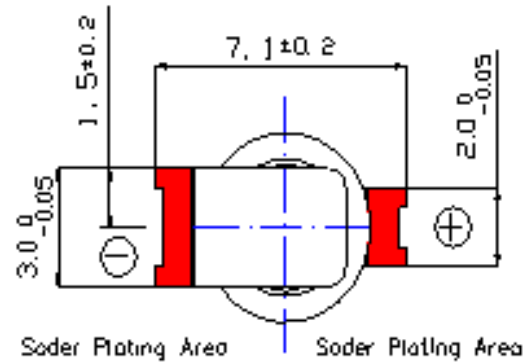

Recommendable PCB layout

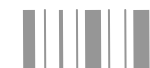
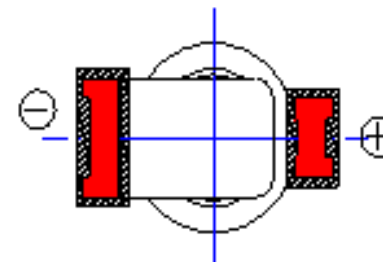
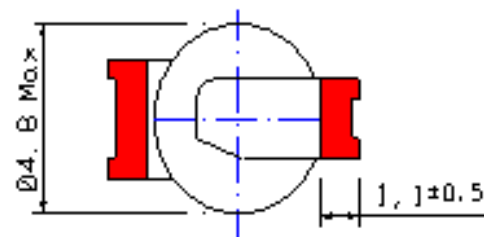
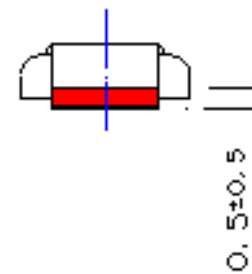
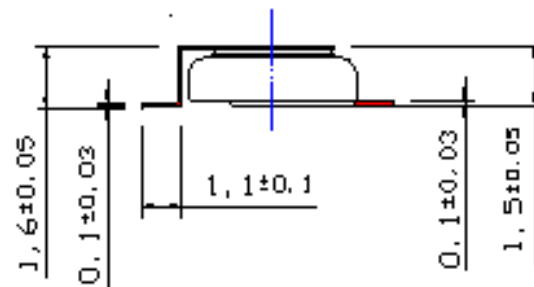

1-3-2 Dimensions in mm

Energy Storage Innovator

● SM3R3703 T01

Not to scale

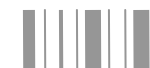
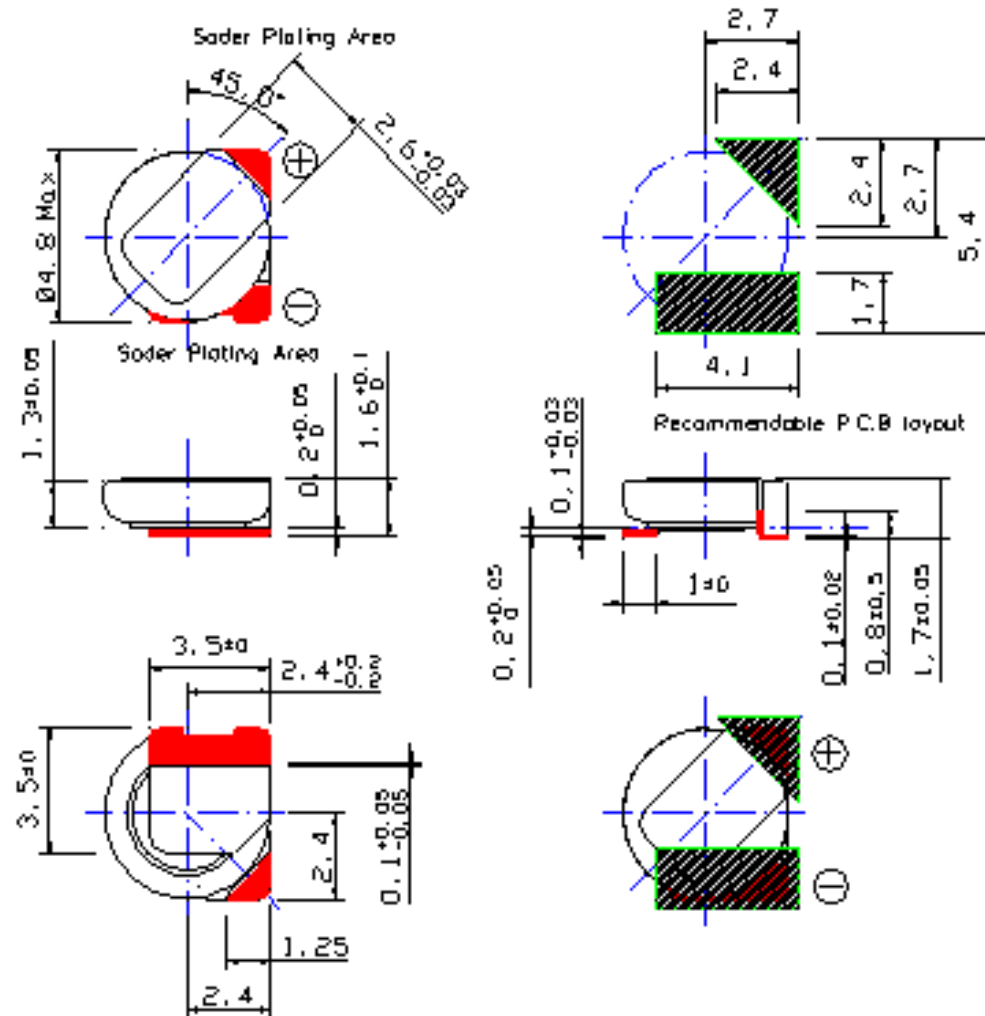

1-3-3 Dimensions in mm

Energy Storage Innovator

● SM3R3703 T02

Not to scale

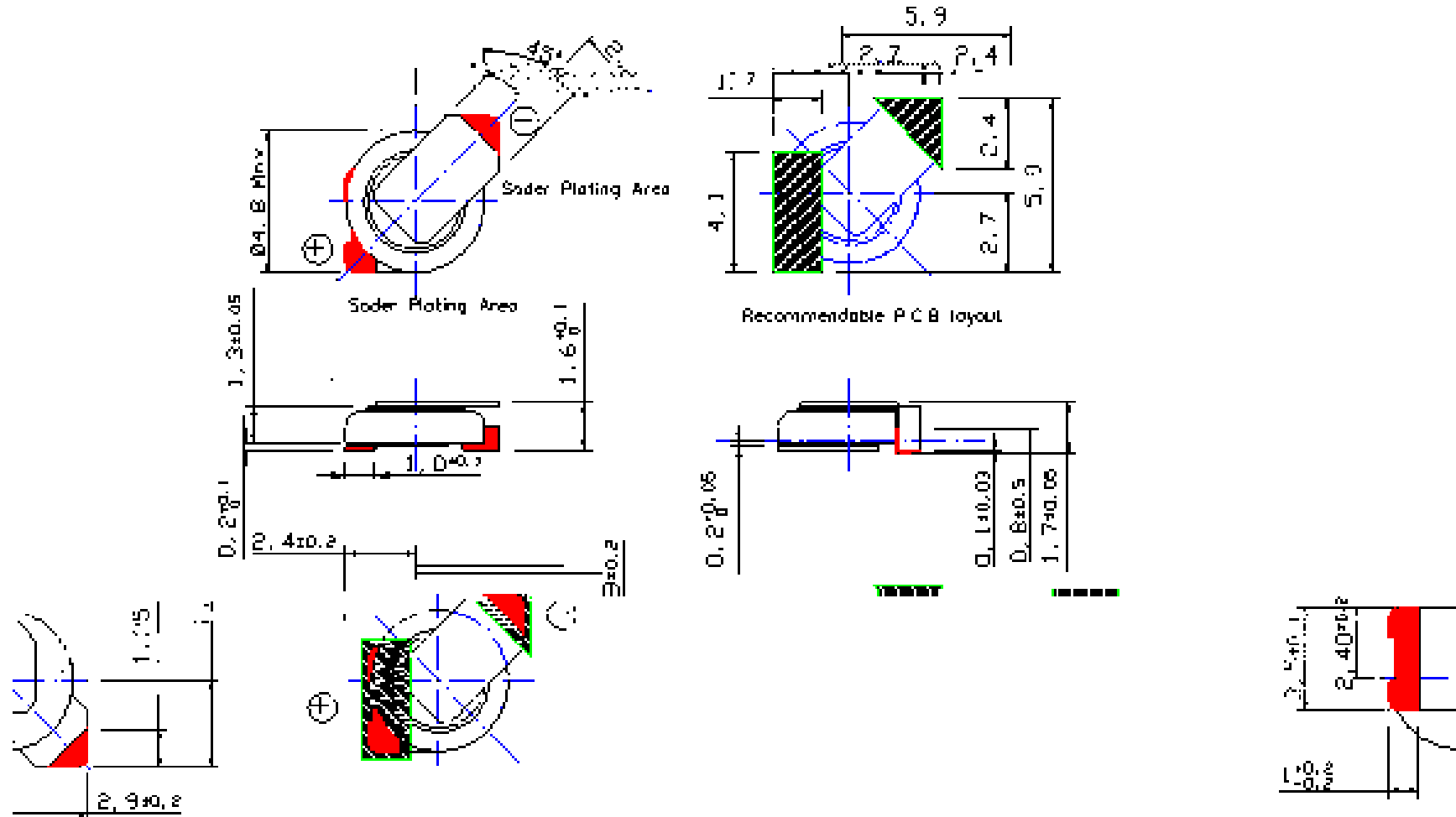

1-3-3 Dimensions in mm

Energy Storage Innovator

● SM3R3703 H02R

Not to scale

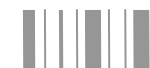
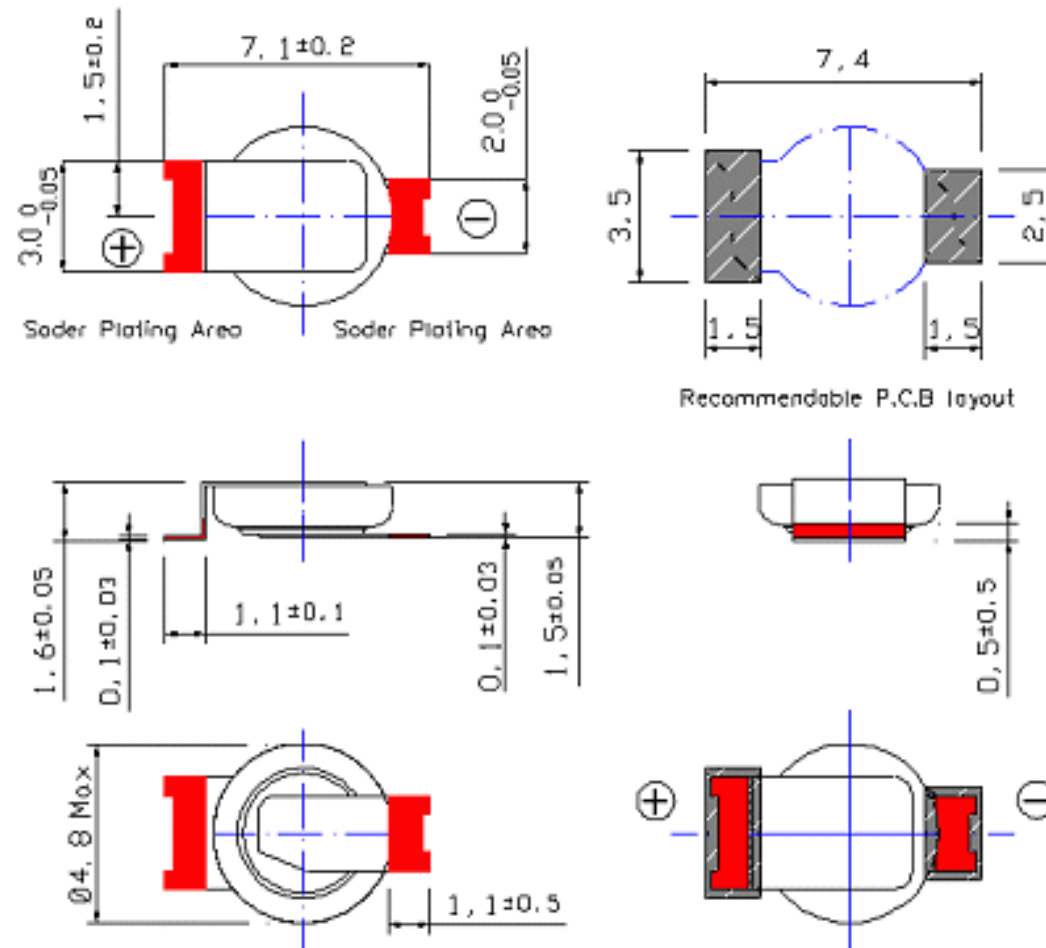

1-4-1 Carrier tape dimensions in mm

Energy Storage Innovator

● SM3R3703 H01

Not to scale

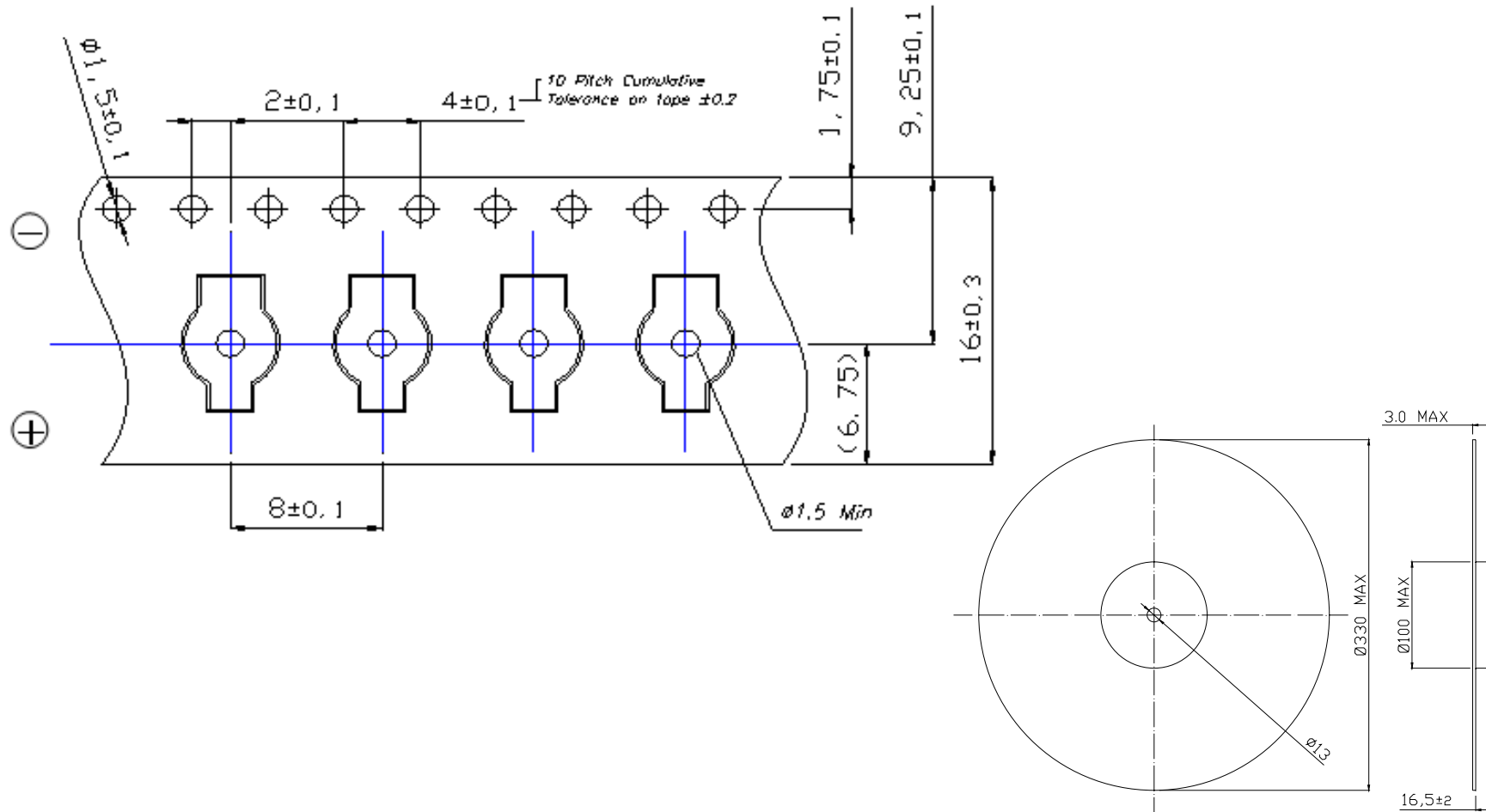

Quantity : 4,000pcs in Reel



1-4-2 Carrier tape dimensions in mm

Energy Storage Innovator

● SM3R3703 T01

Not to scale

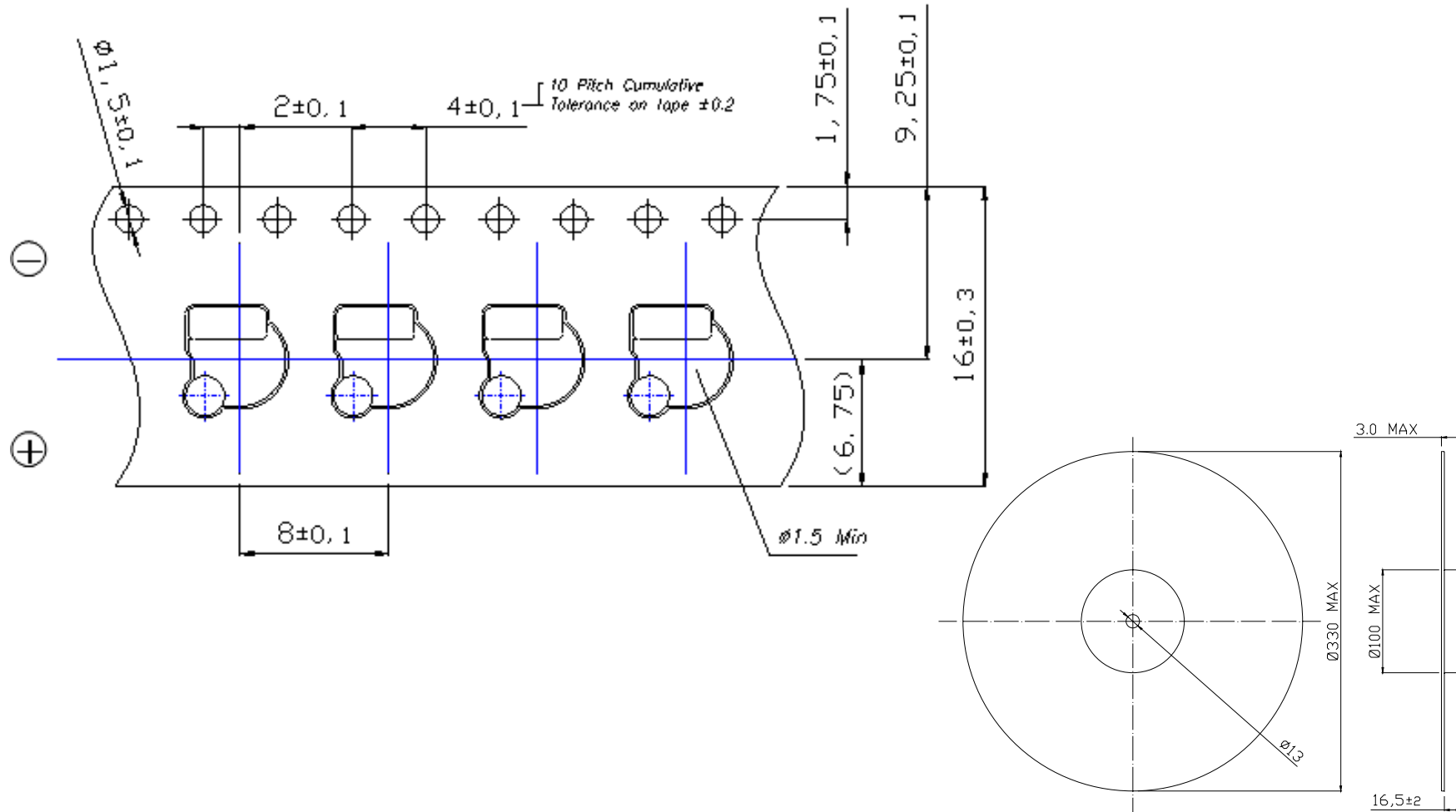

Quantity : 4,000pcs in Reel



1-4-3 Carrier tape dimensions in mm

Energy Storage Innovator

● SM3R3703 T02

Not to scale

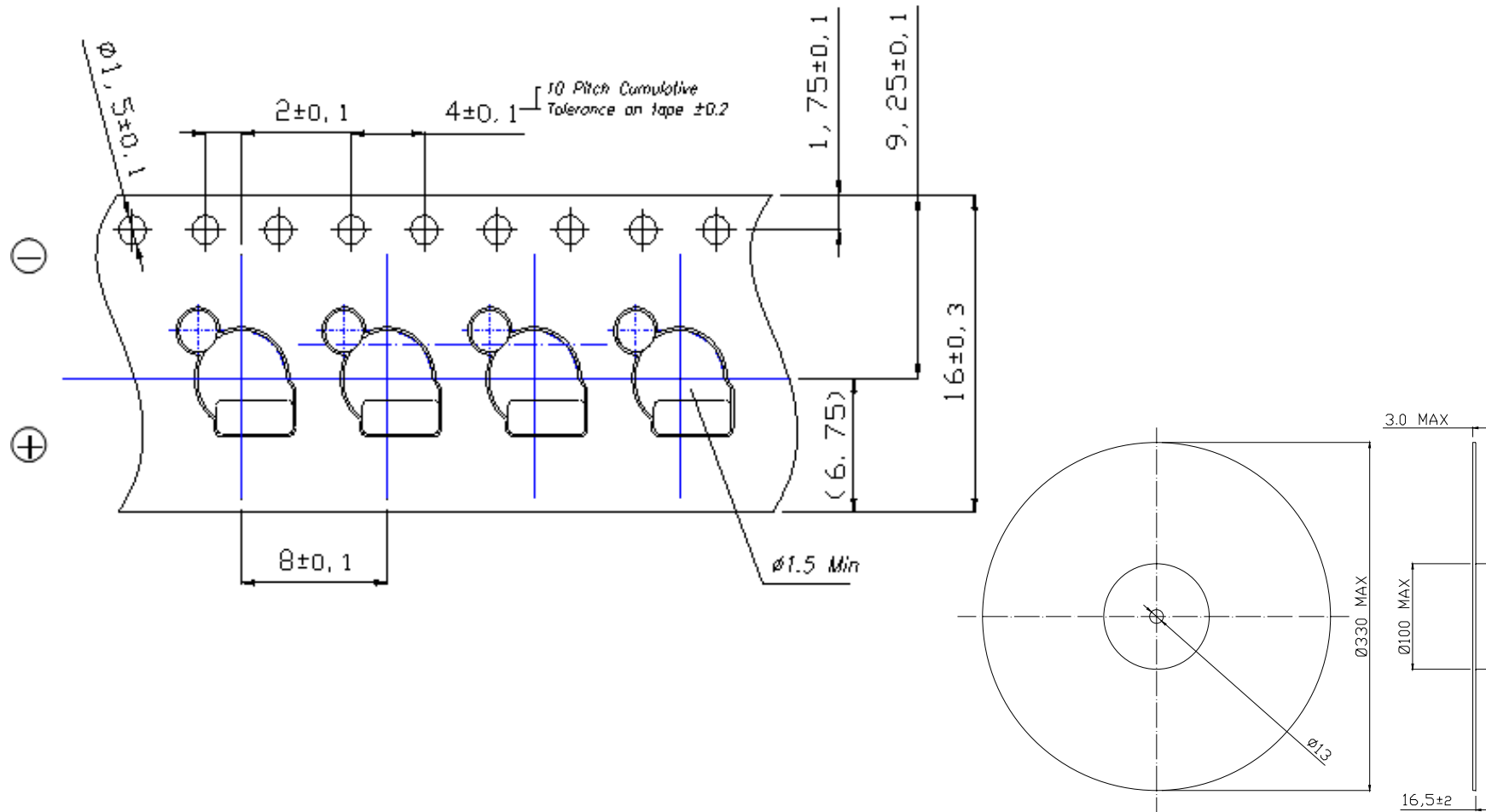

Quantity : 4,000pcs in Reel

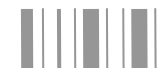

1-4-3 Carrier tape dimensions in mm

Energy Storage Innovator

● SM3R3703 H02R

Not to scale

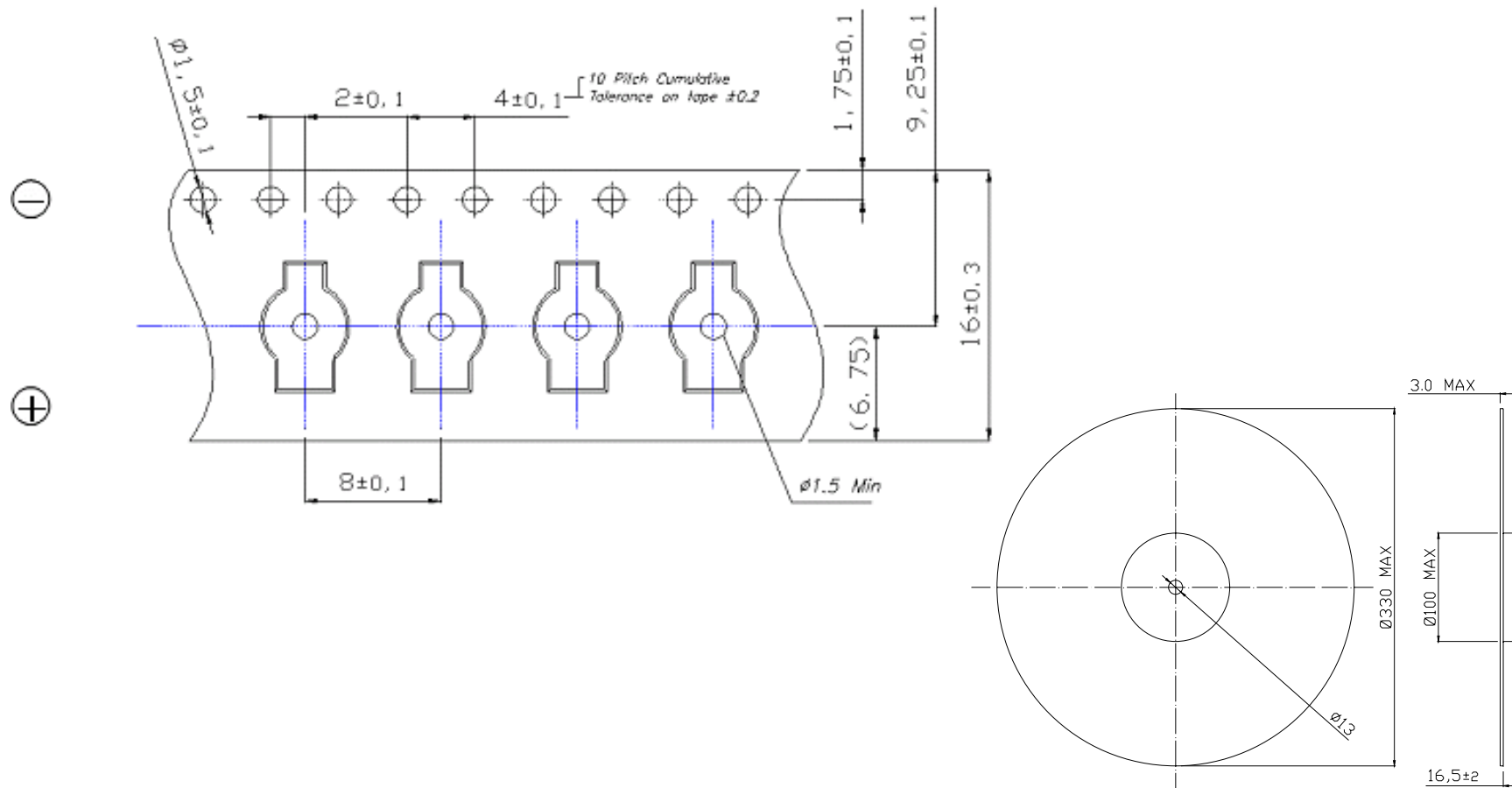

Quantity : 4,000pcs in Reel

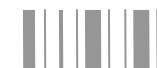

● SM3R3703

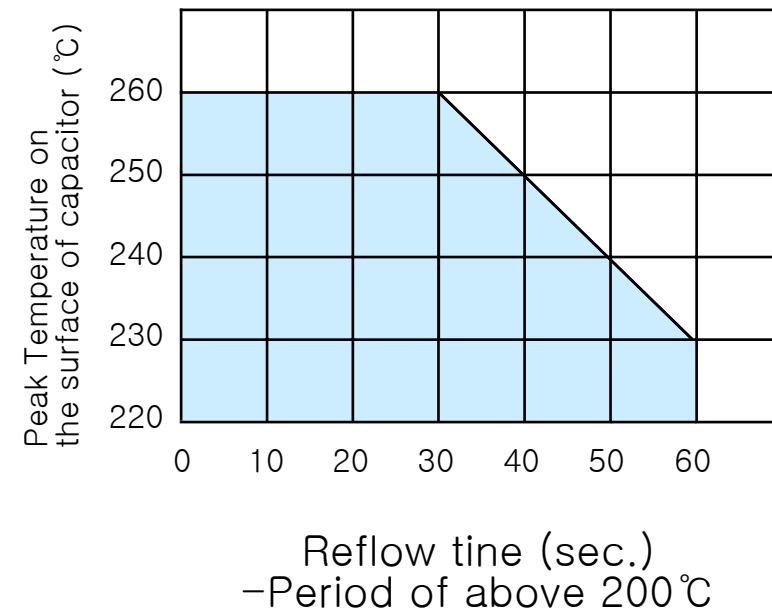
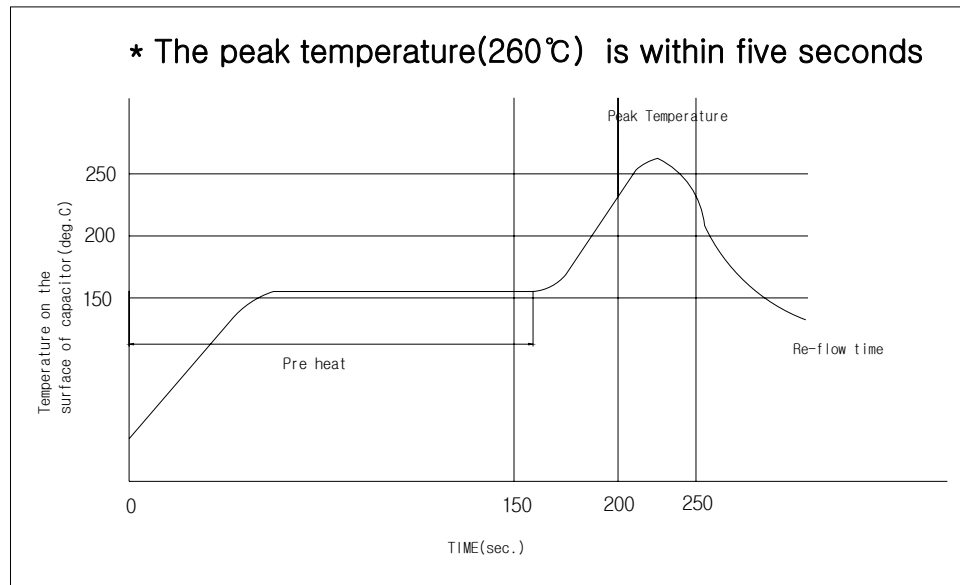

- * Do NOT reflow soldering, when cell voltage is above 0.3V
- * The time of repeated reflow soldering must be two times or less.

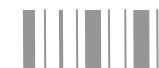

2. Product Characters

2-1 Measuring Method Of Characteristics

2-2 Endurance

2-3 Charge/Discharge Cycle

2-4 Discharge Character

2-5 Low temperature characteristics

2-6 Self-Discharge characteristics

2-7 High humidity characteristics

2-8 Reflow soldering DATA



2-1 Measuring method of characteristics

<p>Capacitance (F)</p>	<p>1) CHARGE THE STARCAP WITH 3.3V 2) READ THE TIME TAKEN FOR THE VOLTAGE TO RISE FROM $2 \pm 0.05V$ TO $3.3 \pm 0.05V$. THE TIME MEASURED IS INDICATED BY "T". 3) CALCULATE CAPACITANCE USING THE FOLLOWING FORMULA. $C = 10^{-3}A \times T \text{ sec} / (V_1 - V_2)V \text{ [F]}$ * Discharge Current : $10\mu A$</p>	
<p>Leakage Current (μA)</p>	<p>1) APPLY $3.3 \pm 0.1V$ TO THE STARCAP. 2) MEASURE V_r AFTER 30 ± 0.5 MIN. 3) CALCULATE CURRENT USING THE FOLLOWING FORMULA. $LC = (V_R / R_C) \times 10^3 \text{ [mA]}$</p>	
<p>ESR (Ω, @1kHz)</p>	<p>MEASURE ESR BY THE LCR METER. FREQUENCY : 1kHz BIAS VOLTAGE : 0V $ESR = V_C / 10^{-3} \text{ [\Omega]}$</p>	

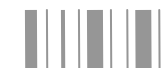

2-2-1 Endurance (ESR)

- Applied Temperature : $60^{\circ}\text{C} \pm 2\text{deg.C}$
Applied Voltage : 3.3V DC
Test time : $1,000 \pm 24$ hours

Measuring instrument : HIOKI 3060 Hi-TESTER
Convection Oven : Yamato DKN811

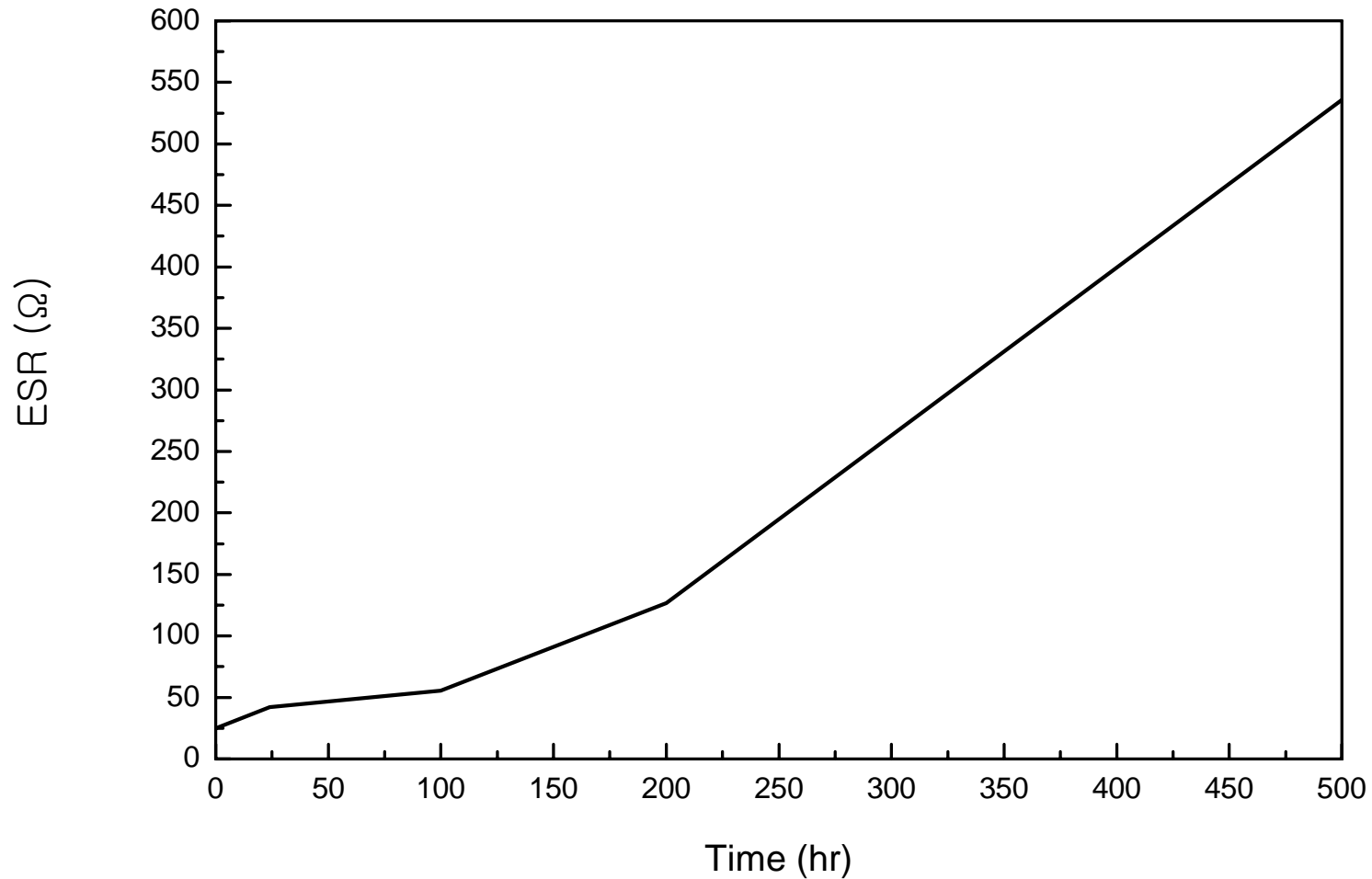

2-2-2 Endurance (Capacitance)

- Applied Temperature : $60^{\circ}\text{C} \pm 2\text{deg.C}$
Applied Voltage : 3.3V DC
Test time : $1,000 \pm 24$ hours

Measuring instrument : Toyo TYS-90CJ012CNNB-N240
Convection Oven : Yamato DKN811

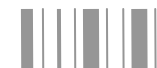
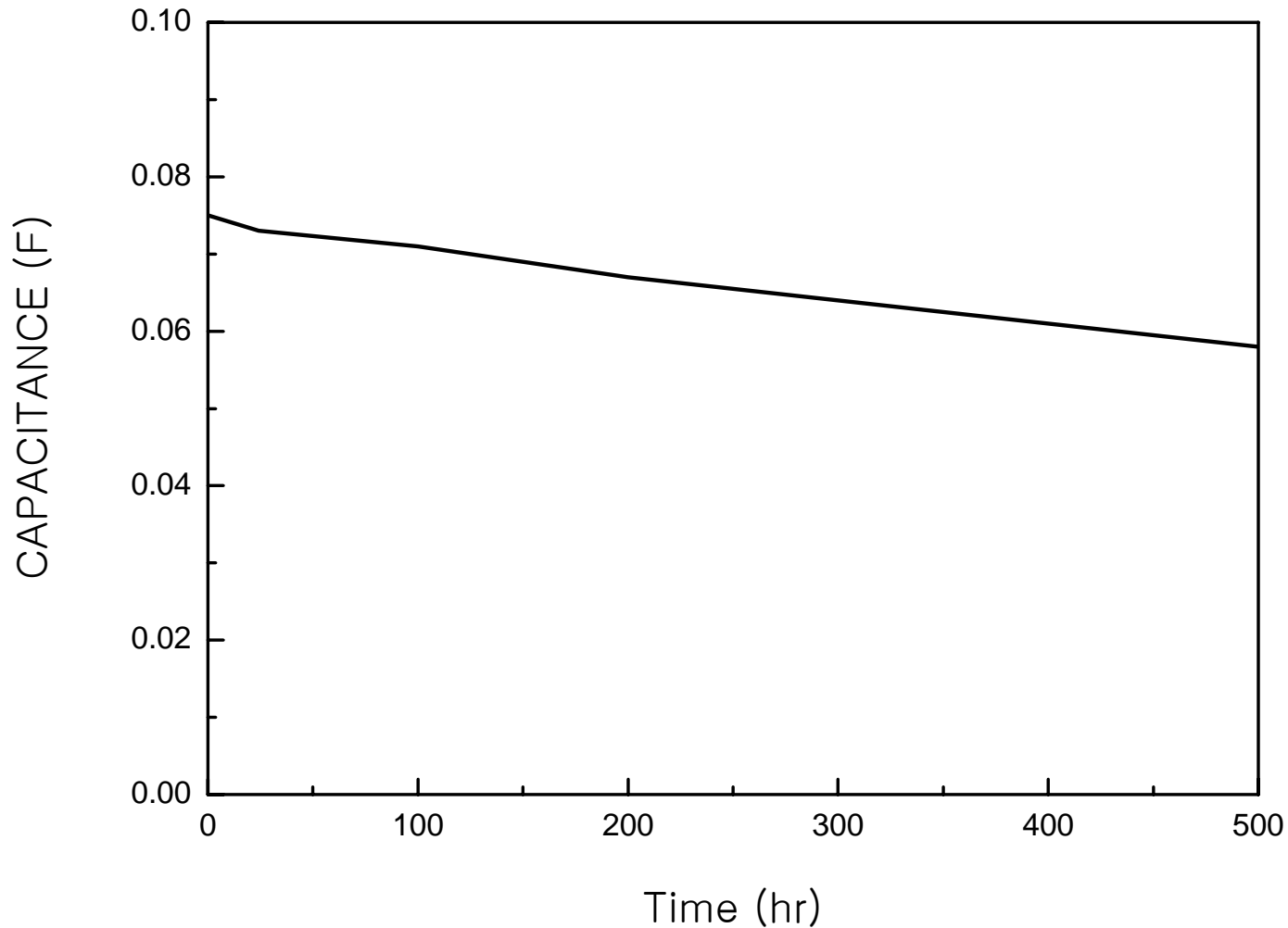

2-3-1 Charge/Discharge Cycle (ESR)

Energy Storage Innovator

- Charge voltage : 3.3V , Charge time : 30sec.
Discharge resistance : 1 K Ω , Discharge time : 30 sec.

Measuring instrument : HIOKI 3060 Hi-TESTER
Cycle tester : Human tech. Cycle TESTER

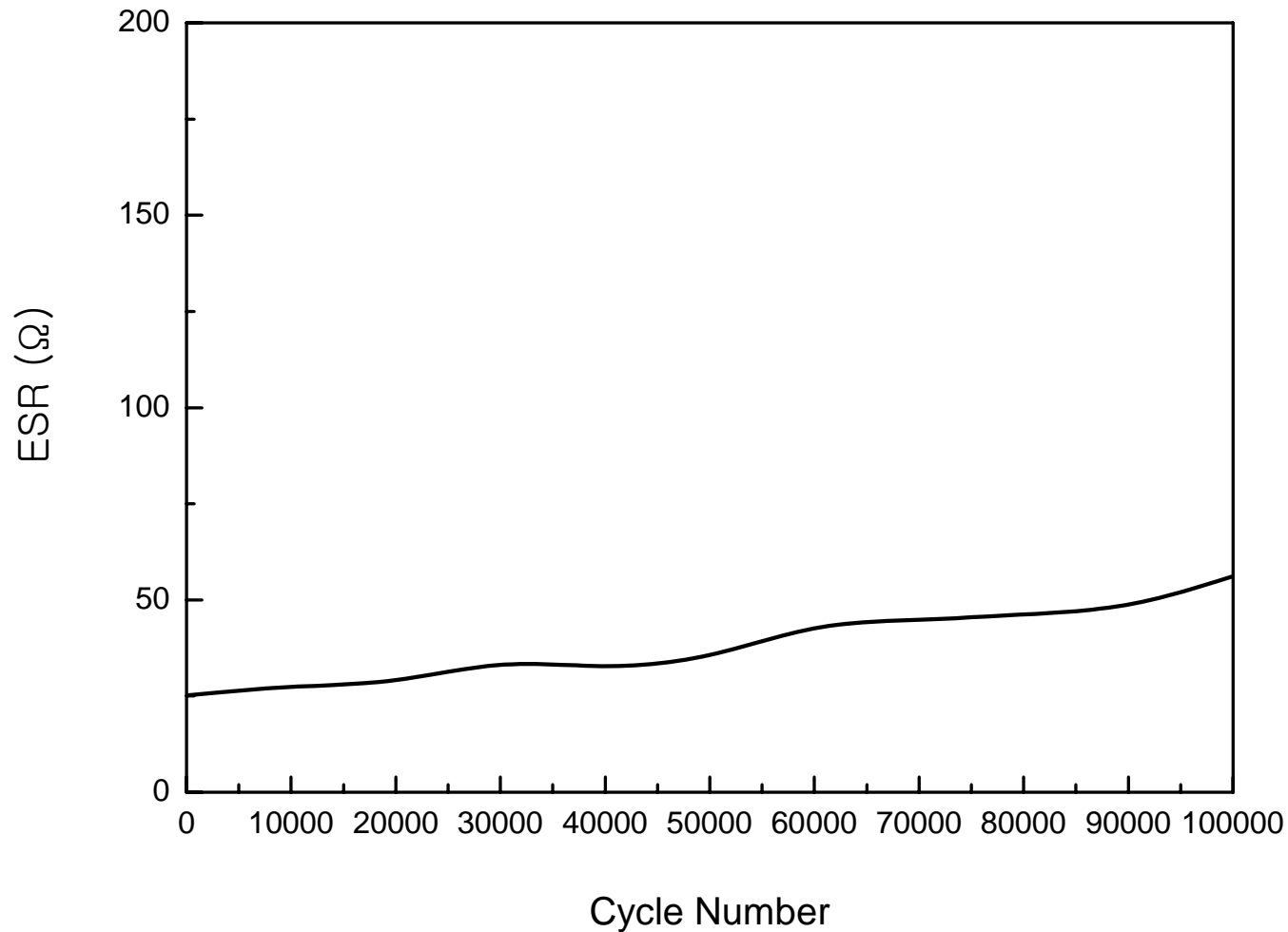

2-3-2 Charge/Discharge Cycle (Capacitance) *Energy Storage Innovator*

- Charge voltage : 3.3V , Charge time : 30sec.
Discharge resistance : 1 K Ω , Discharge time : 30 sec.

Measuring instrument : Toyo TYS-90CJ012CNNB-N240

Cycle tester : Human tech. Cycle TESTER

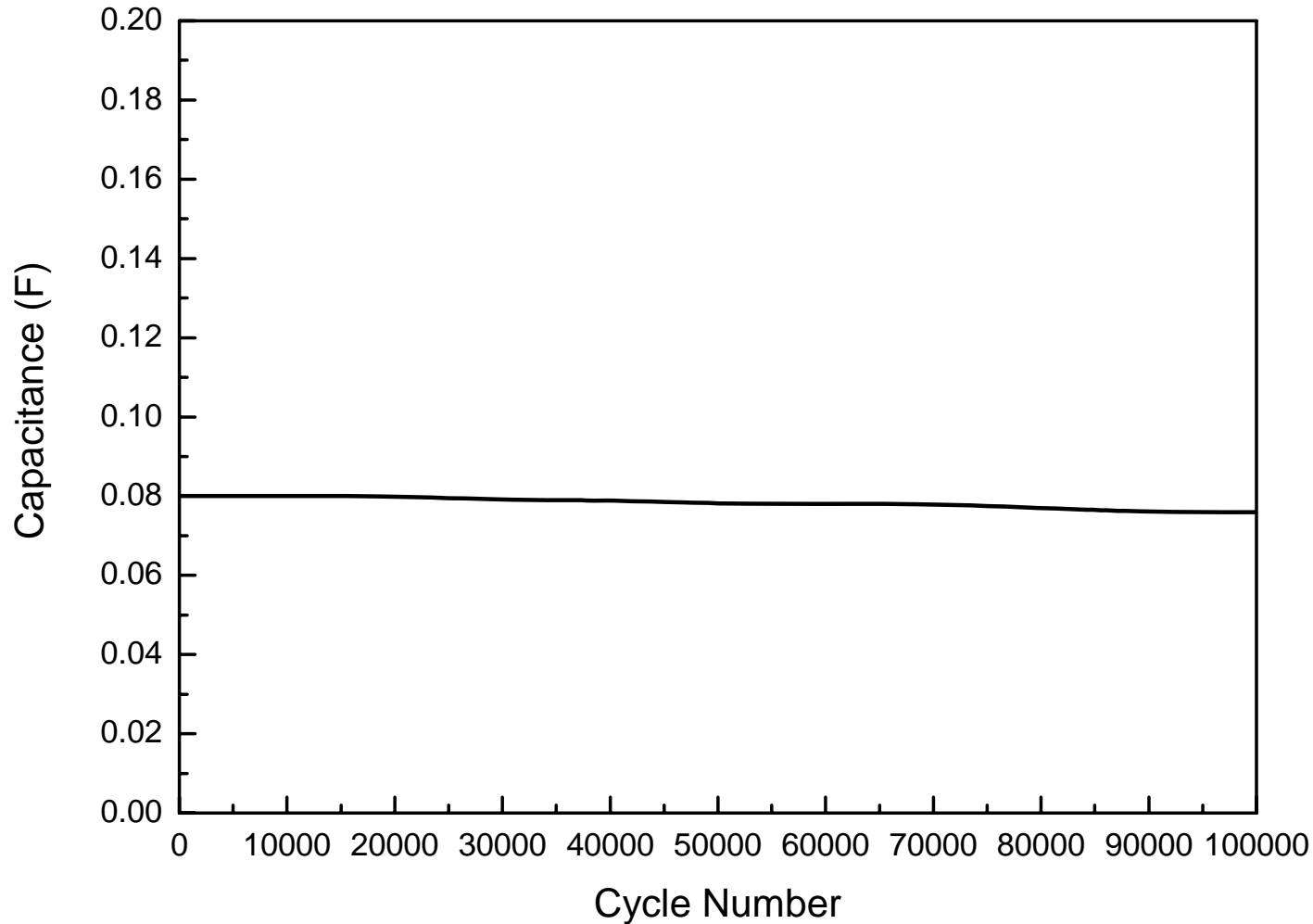

2-4-1 Discharge Character (SM 3R3 703)

Energy Storage Innovator

- Charge voltage : 3.3Vdc , Charge current : 1mA , Charge time : 30min.
Cut-off voltage : 1.0V, Discharge current : 14 μ A

Measuring instrument : Toyo TYS-90CJ012CNNB-N240

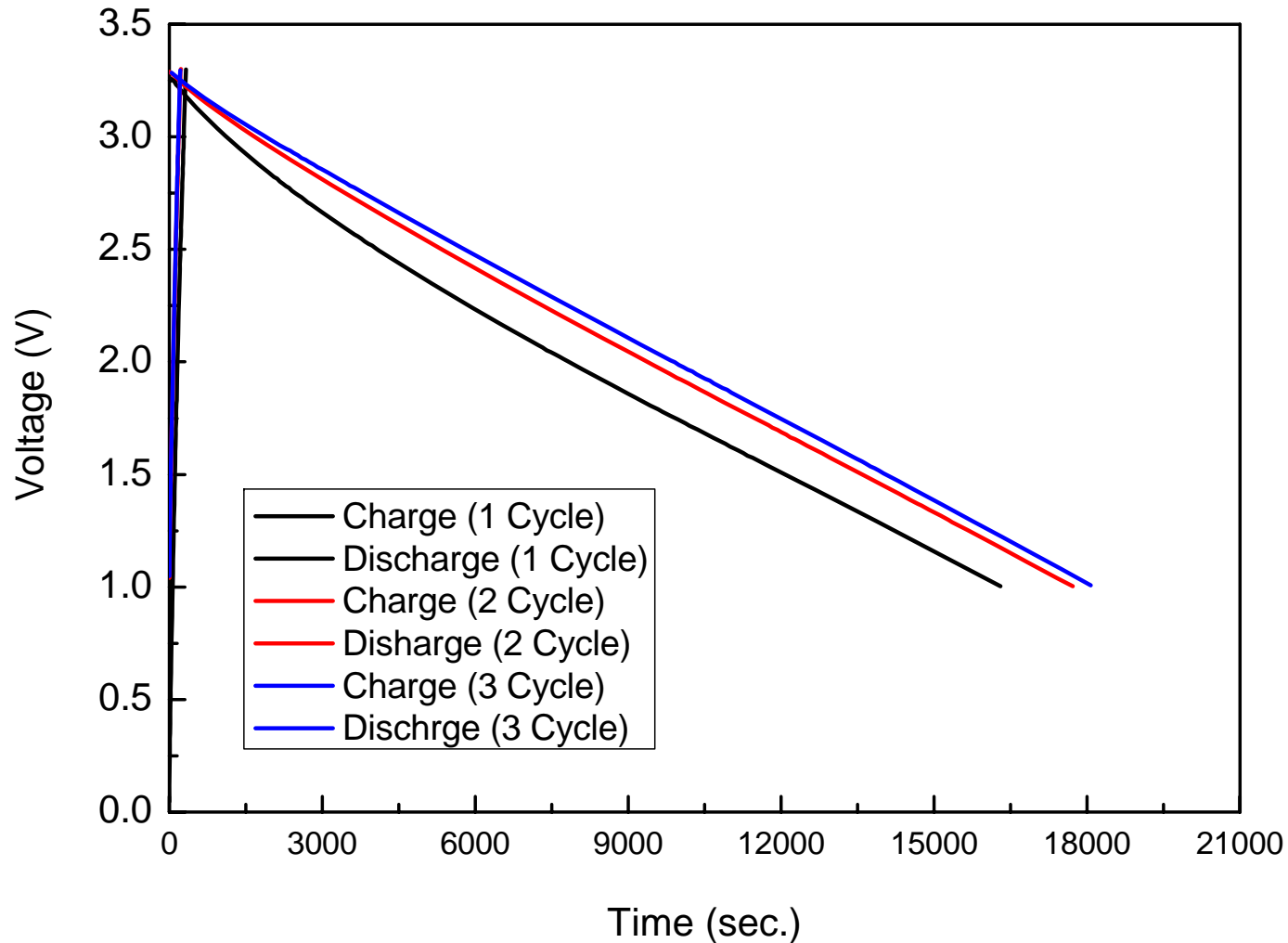

2-4-2 Discharge Character (SM 3R3 703)

Energy Storage Innovator

- Charge voltage : 2.9Vdc , Charge current : 1mA , Charge time : 30min.
Cut-off voltage : 1.0V, Discharge current : 14 μ A

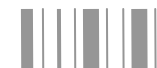
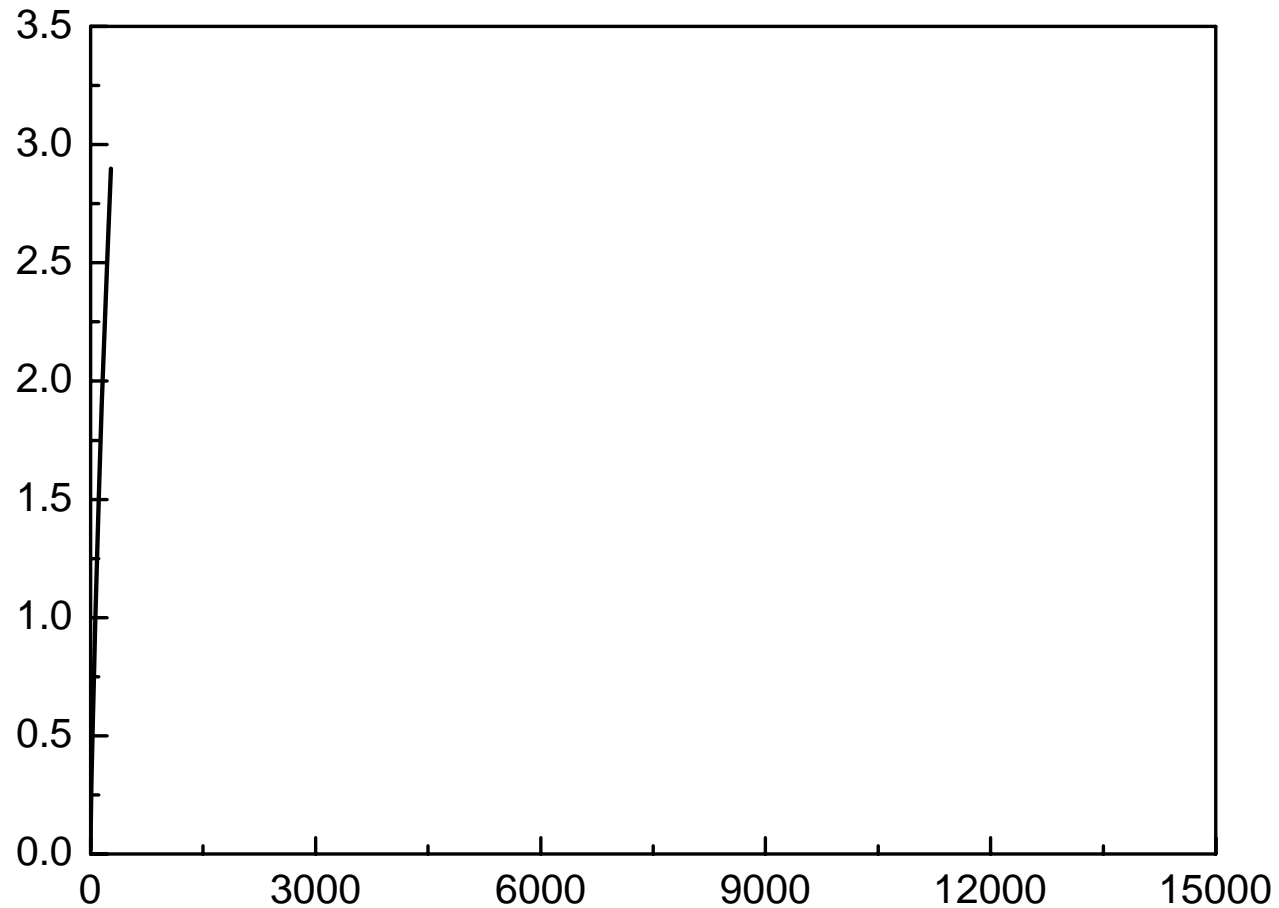

2-4-3 Discharge Character (SM 3R3 703)

Energy Storage Innovator

- Charge voltage : 1.5Vdc , Charge current : 1mA , Charge time : 30min.
Cut-off voltage : 0.8V, Discharge current : 14 μ A

Measuring instrument : Toyo TYS-90CJ012CNNB-N240

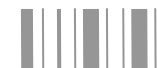
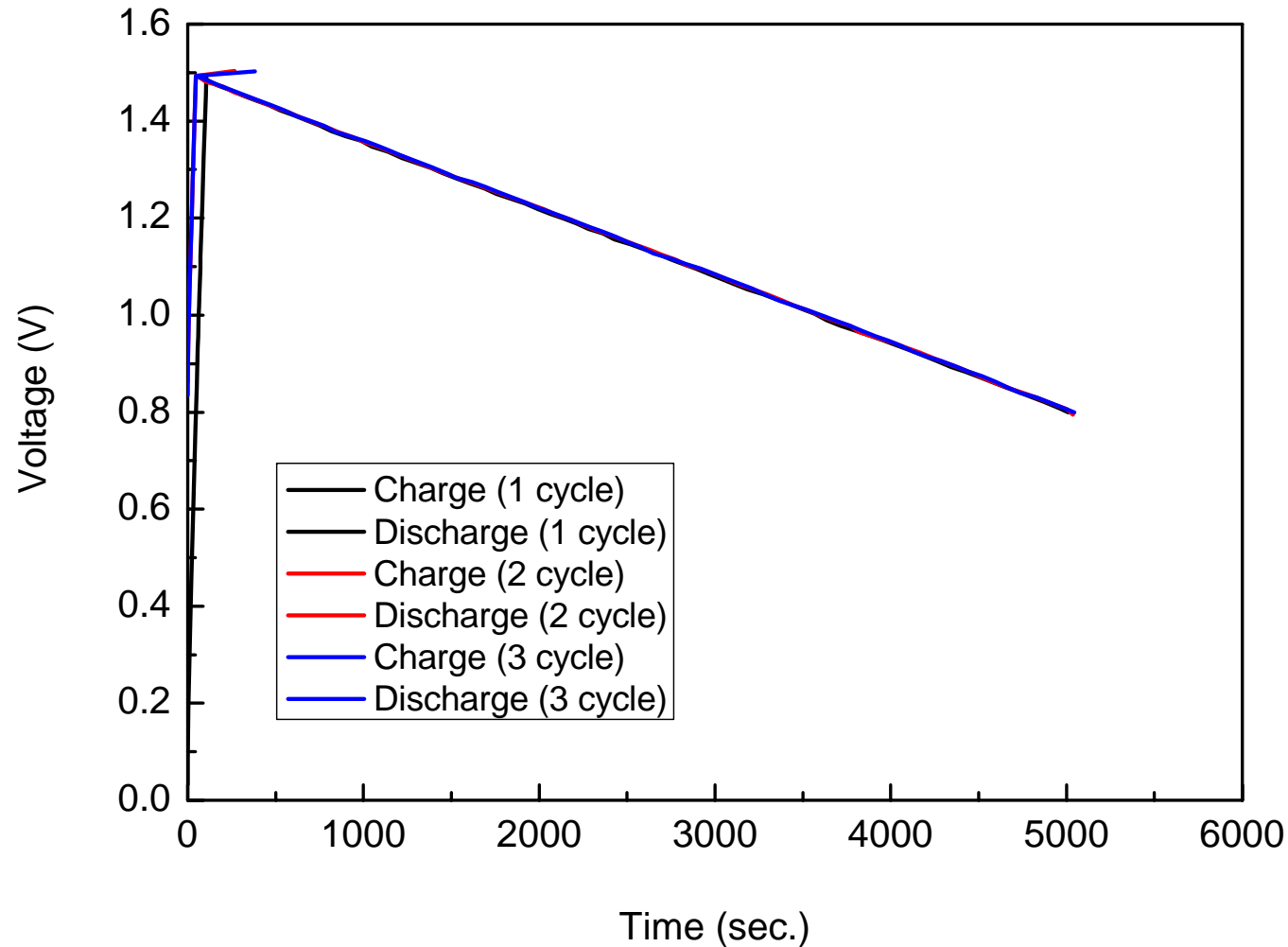

2-5 Low temperature characteristic

Energy Storage Innovator

● Test temperature : $-30^{\circ}\text{C} \rightarrow -25^{\circ}\text{C} \rightarrow -20^{\circ}\text{C} \rightarrow -10^{\circ}\text{C} \rightarrow +25^{\circ}\text{C} \rightarrow +45^{\circ}\text{C} \rightarrow +70^{\circ}\text{C}$

Test time : 8 hours (each 2hours)

Measuring instrument : Toyo TYS-90CJ012CNNB-N240

Chamber : ESPEC PCR-3K

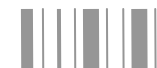
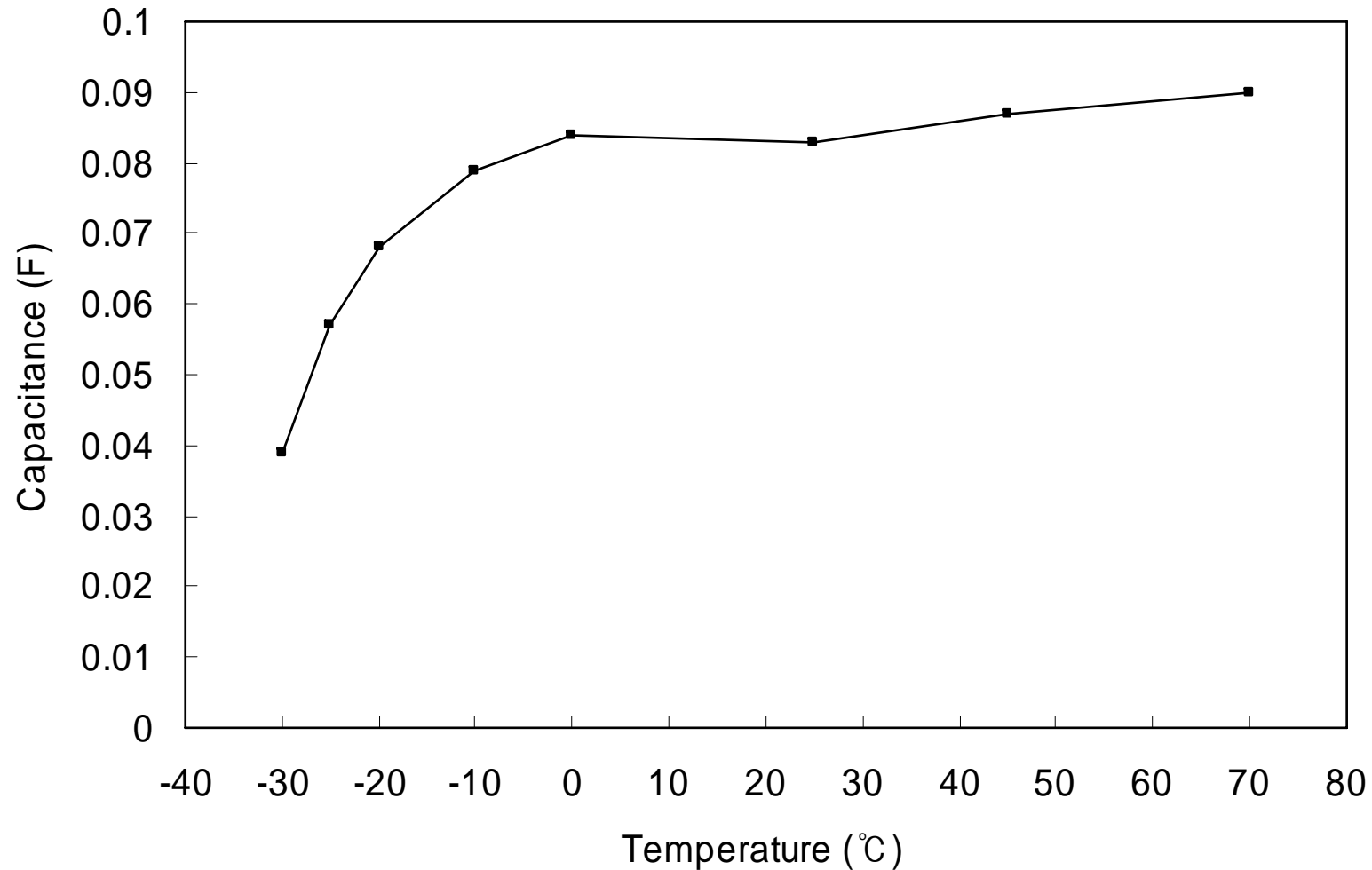

2-6 Self-Discharge characteristics

- Charge voltage : 3.3V DC , Charge time : 1 hours
Test time : 100 hours

Measuring instrument : Human Tech. SD TESTER

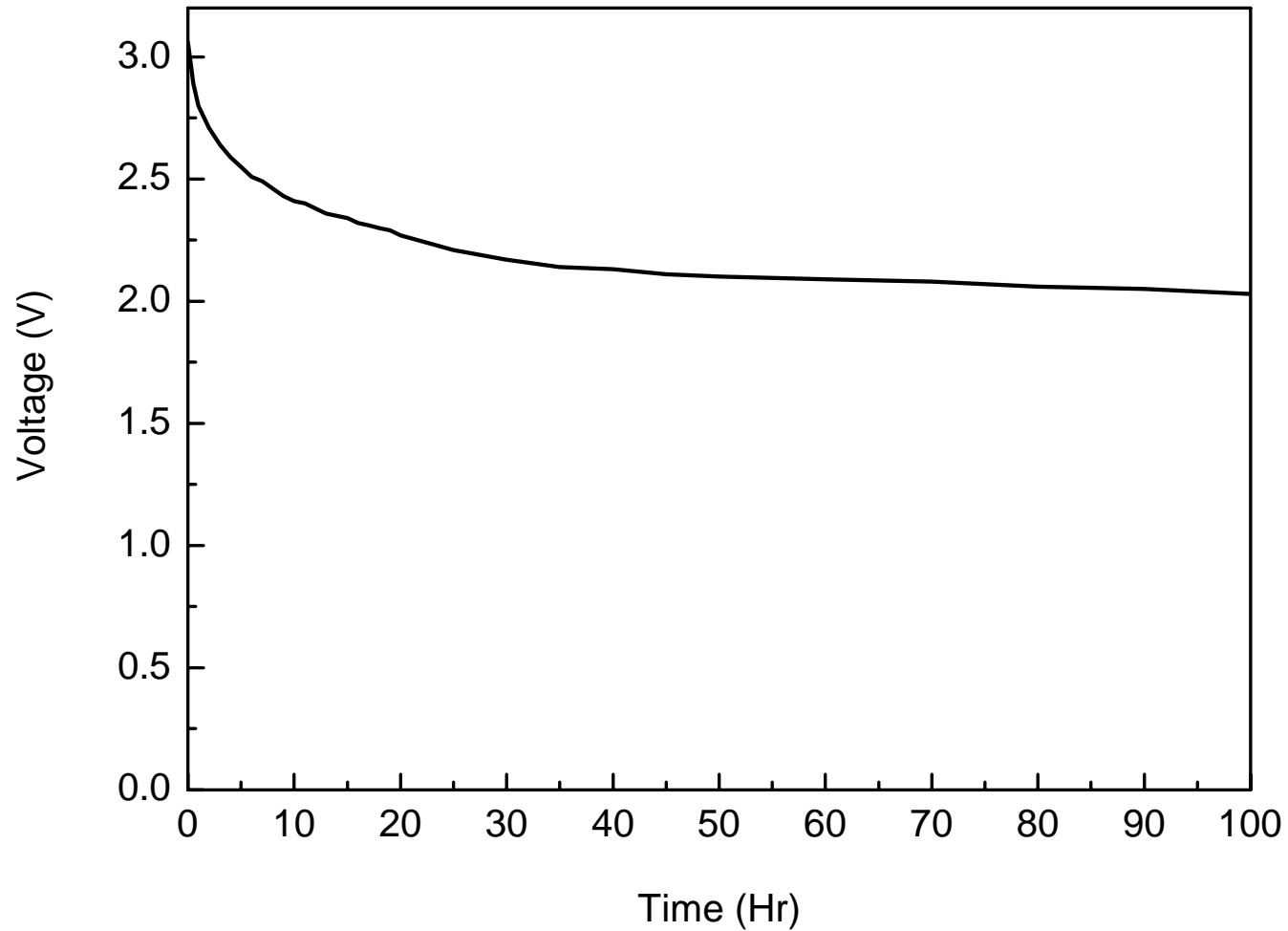

2-7-1 High humidity characteristics (ESR) *Energy Storage Innovator*

● Test time : 240 ± 24 hours

Measuring instrument : HIOKI 3060 Hi-TESTER

Chamber : ESPEC PCR-3K

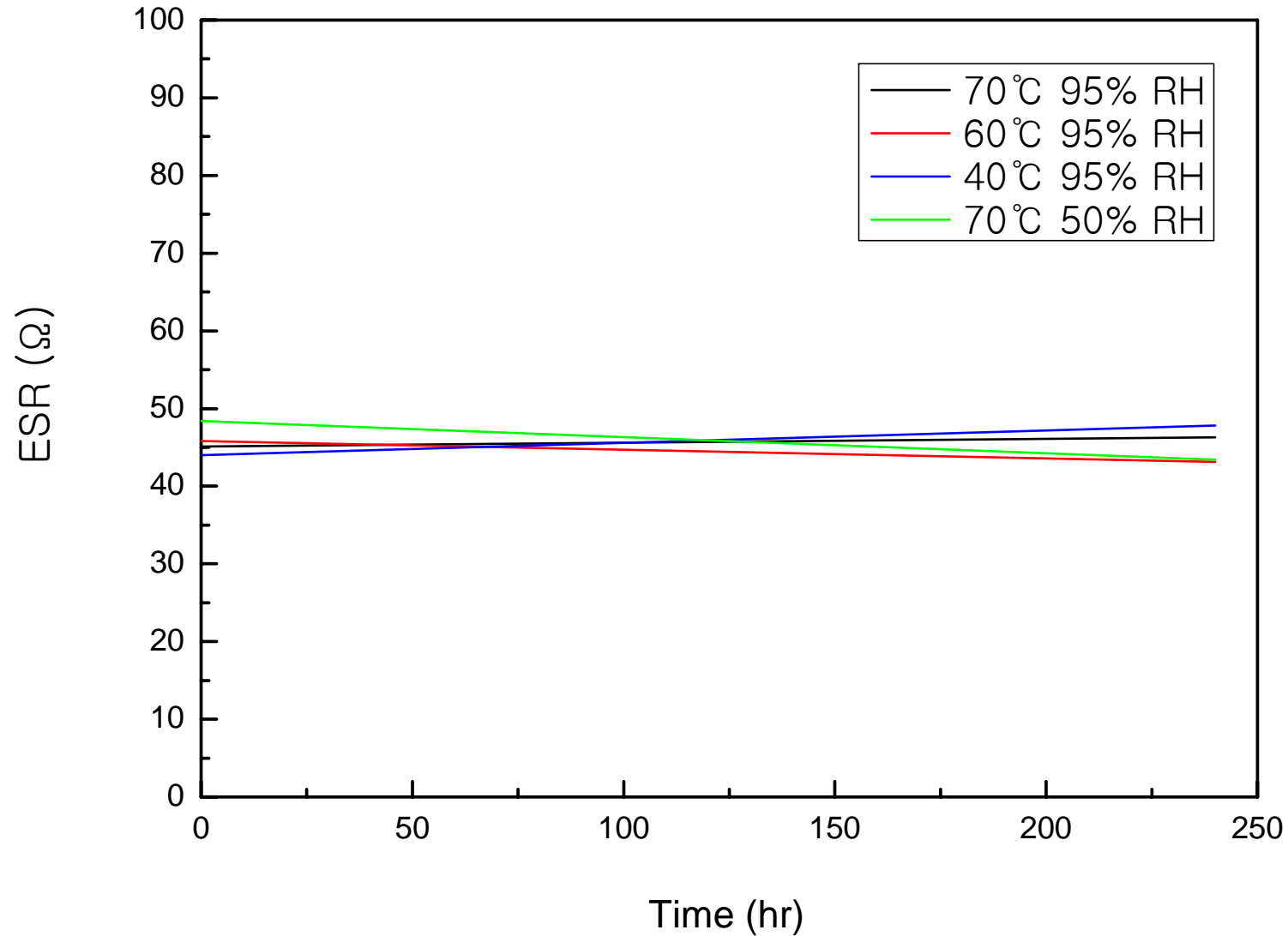

2-7-2 High humidity characteristics (Capacitance) *Energy Storage Innovator*

● Test time : 240 ± 24 hours

Measuring instrument : Toyo TYS-90CJ012CNNB-N240

Chamber : ESPEC PCR-3K

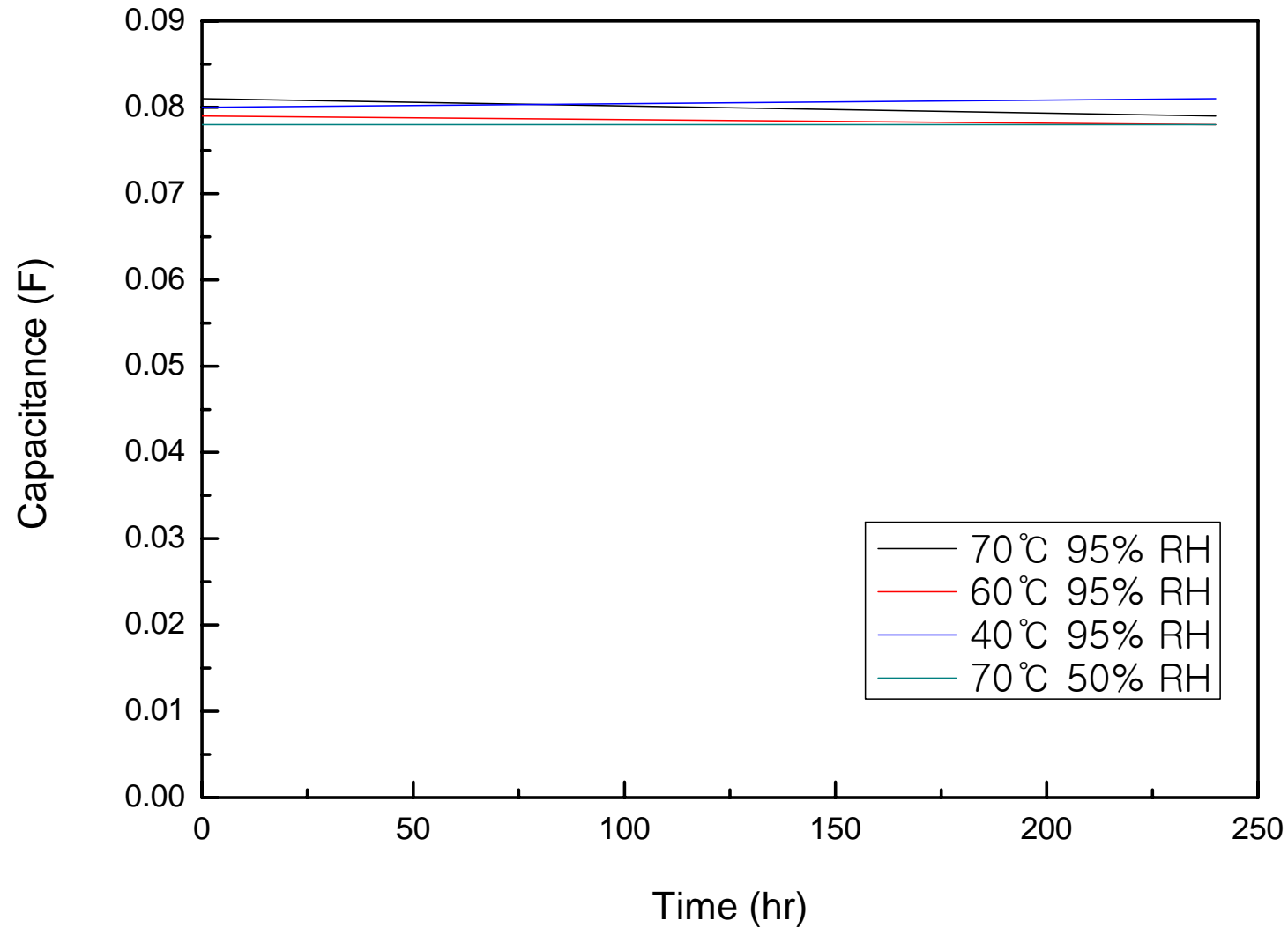

- Following Pb-free reflow condition
 - Above 150°C 180sec. , 200°C 65sec. , 230°C 45sec. 260°C peak 5sec.

Sample : 120EA

Measuring instrument : HIOKI 3060 Hi-TESTER
Reflow Tester : LPKF Pb-free Protoflow

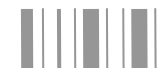
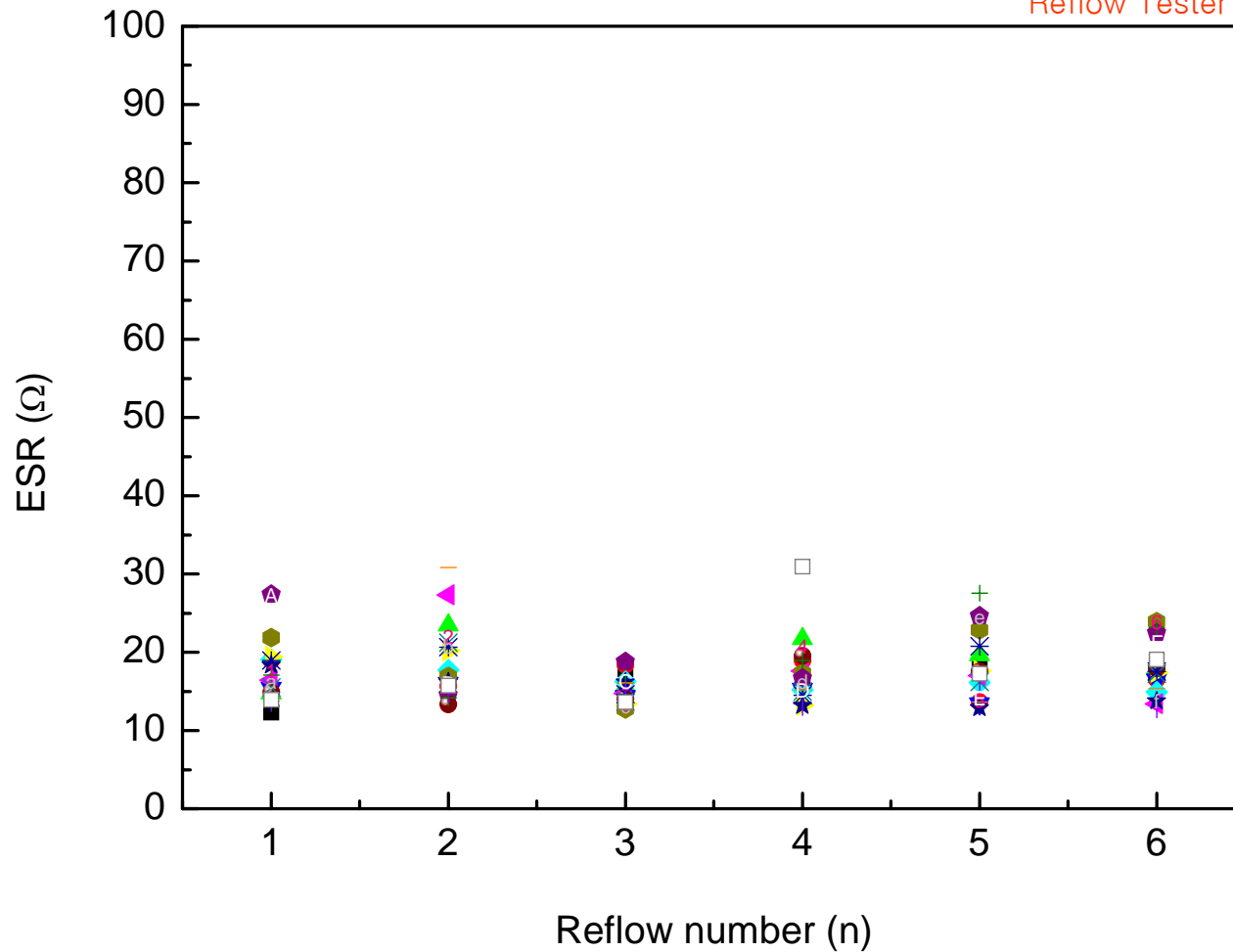

- Following Pb-free reflow condition
 - Above 150°C 180sec. , 200°C 65sec. , 230°C 45sec. 260°C peak 5sec.
- Sample : 120EA

Measuring instrument : Toyo TYS-90CJ012CNNB-N240
Reflow Tester : LPKF Pb-free Protoflow

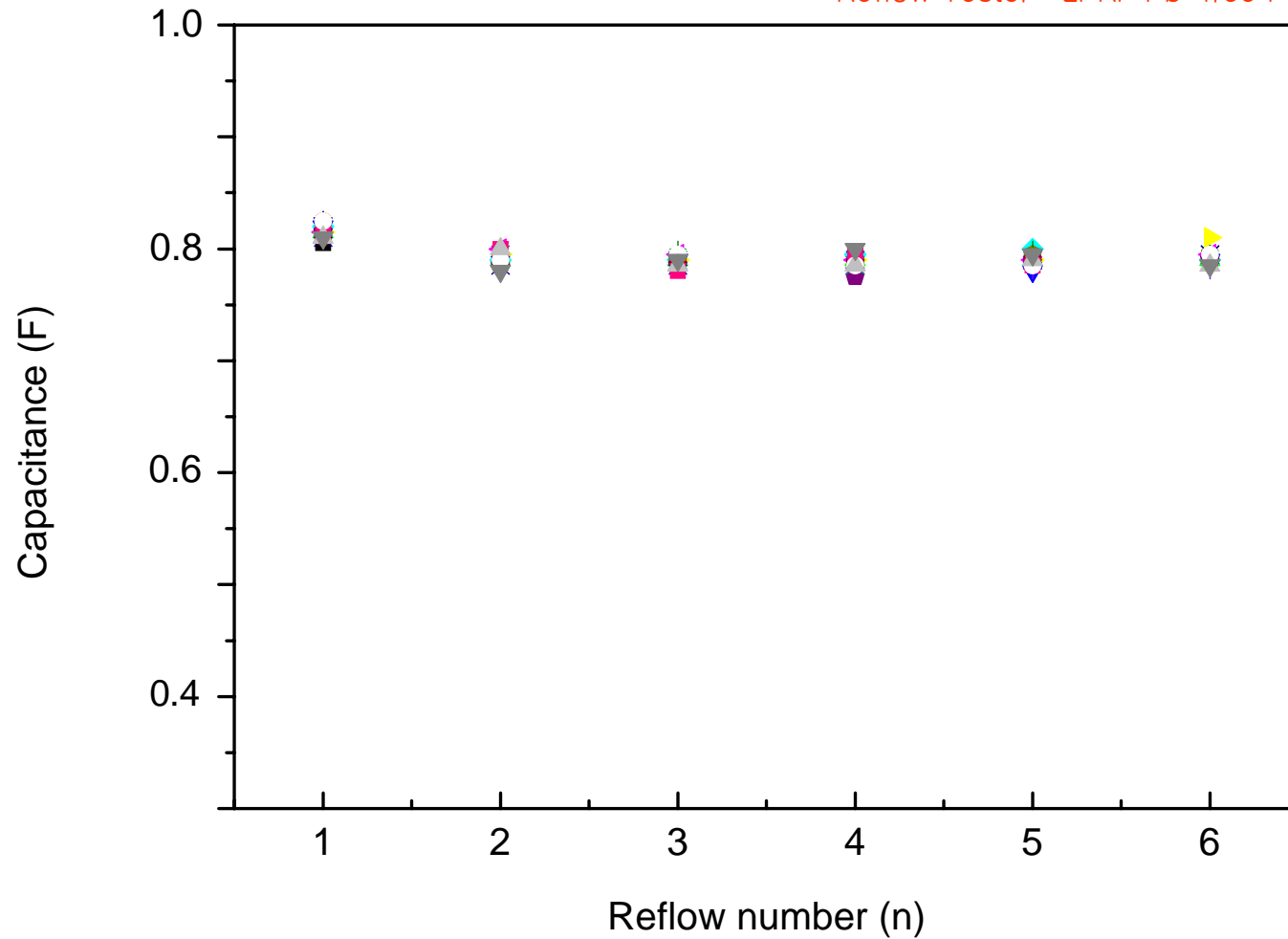

2-9-1 Discharge Character (SM 3R3 703)

Energy Storage Innovator

- Charge voltage : 3.3Vdc , Charge current : 1mA , Charge time : 30min.
Cut-off voltage : 1.0V, Discharge current : 14 μ A

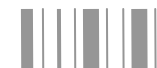
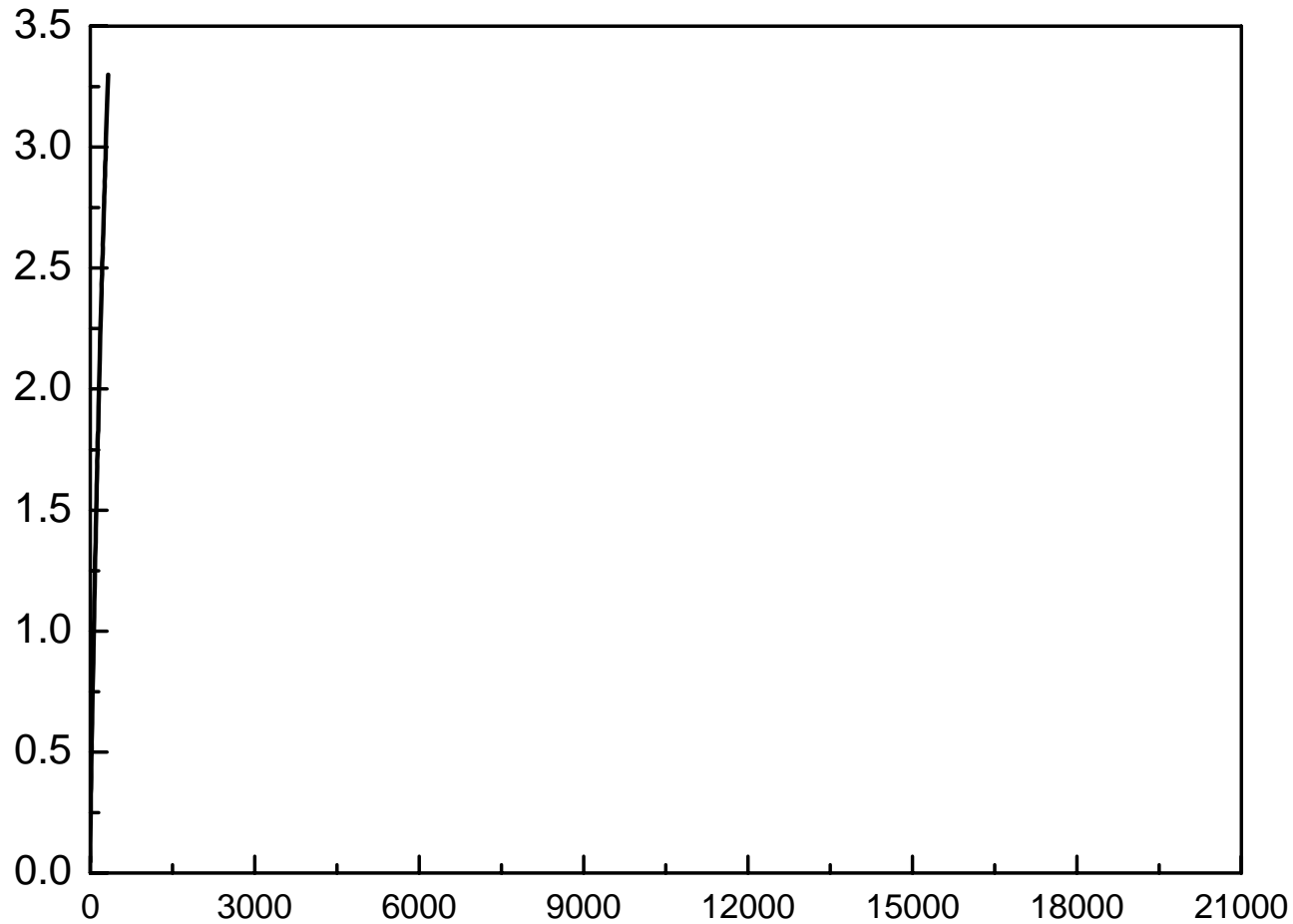

2-9-2 Discharge Character (SM 3R3 703)

Energy Storage Innovator

- Charge voltage : 2.9Vdc , Charge current : 1mA , Charge time : 30min.
Cut-off voltage : 1.0V, Discharge current : 14 μ A

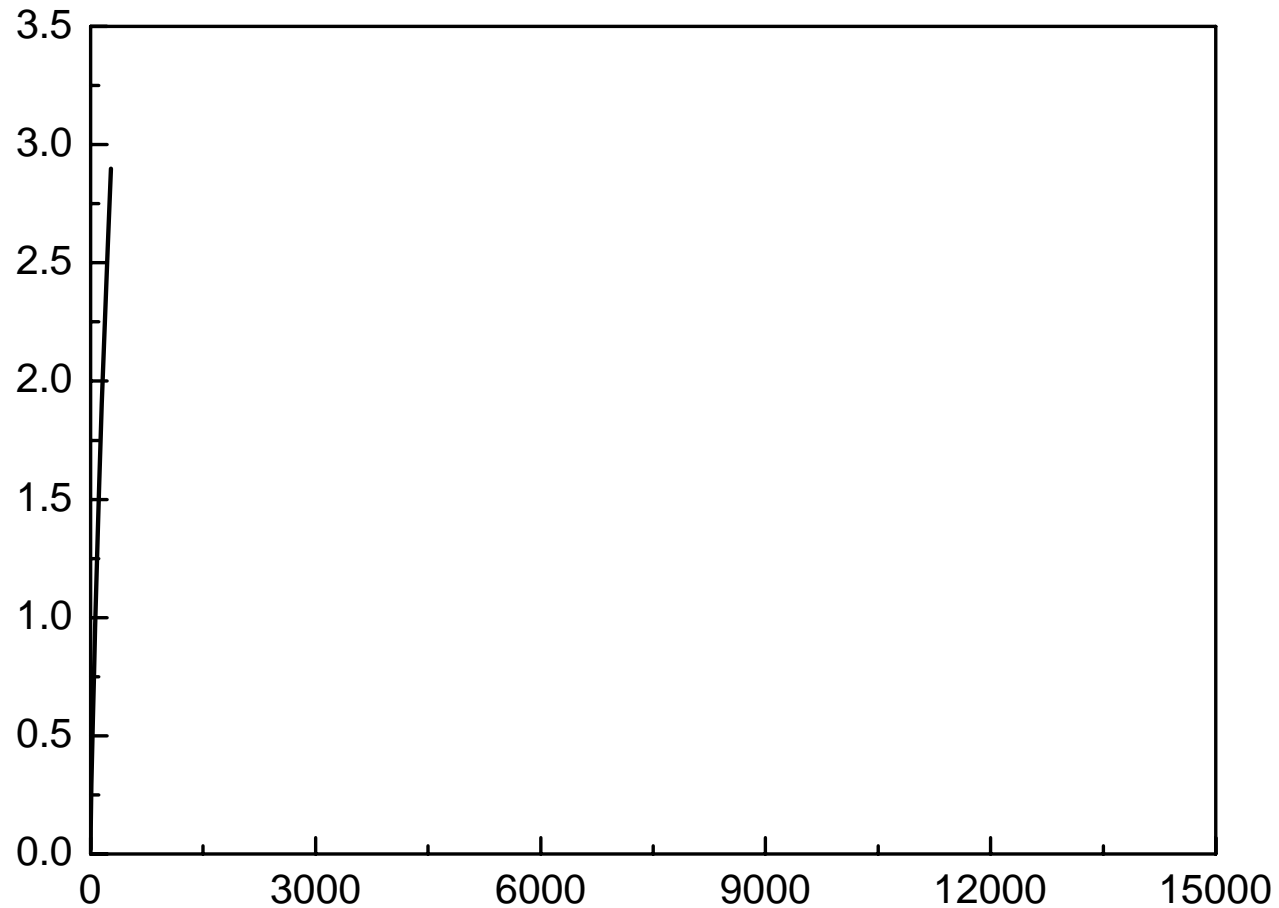

2-9-3 Discharge Character (SM 3R3 703)

Energy Storage Innovator

- Charge voltage : 1.5Vdc , Charge current : 1mA , Charge time : 30min.
Cut-off voltage : 0.8V, Discharge current : 14 μ A

Measuring instrument : Toyo TYS-90CJ012CNNB-N240

